

# PDLVL100GP16

## Surge Arrester

Specifications	
Reference Voltage $U_{ref}$	80V – 120V at 1mA dc
Max. Continuous Operating Voltage $U_c$	60Vdc
Rated Voltage $U_r$	60Vdc
Maximum withstand Voltage $U_w$	60Vdc
Short Circuit Energy Integral	2 x 0.5 x 10 <sup>6</sup> A <sup>2</sup> s 2 x 60 x 10 <sup>6</sup> A <sup>2</sup> s
Maximum Leakage current at 60VDC	<10 $\mu$ A
Maximum Discharge Current 8/20 $\mu$ s	1 x 25kA 10 x 10kA
Tightening Torque for M8 fitting	19Nm max
Tightening Torque for M16 fitting	80Nm max
Part Code:	<b>PDLVL100GP16</b>

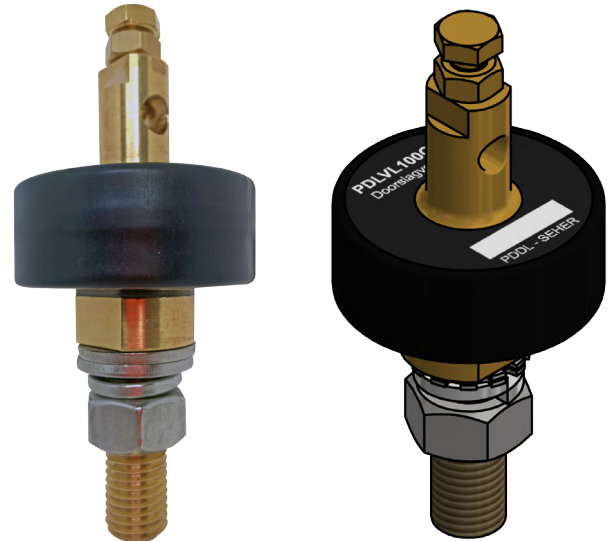

Dimensions in mm

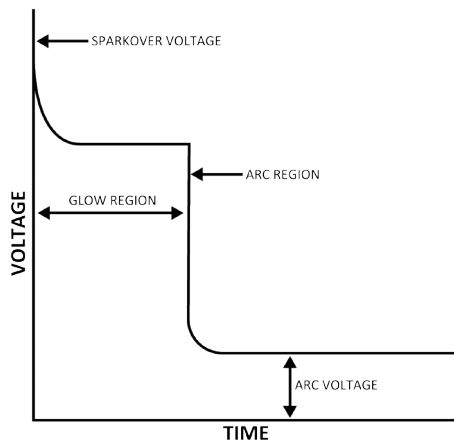

Typical operation characteristics of the Gas Discharge Tube (GDT) component used in the PDLVL100G.

In an overvoltage 'fault' condition, the GDT presents itself as a virtual short circuit. This effectively diverts the resultant surge current to the referenced ground plane.

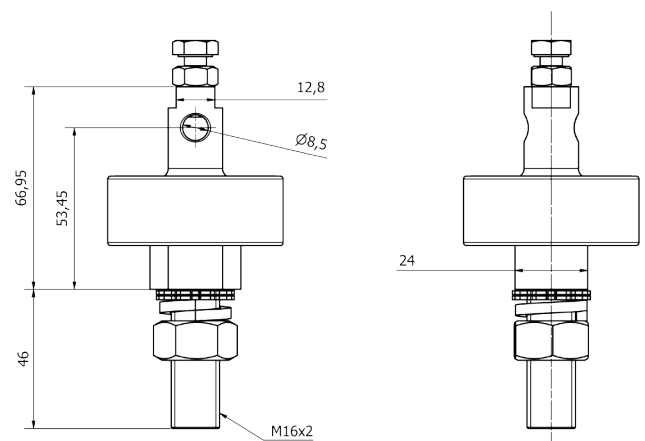

The above/below voltage versus time curve illustrates the key operating areas of the GDT, with the prospective current that will flow through the device largely dependant on the source impedance.

With the voltage increasing across the GDT terminals, at a critical point it will begin to conduct. It has entered the Glow Region. Here the gas within the device begins to rapidly ionise, lowering the internal impedance. Surge 'fault' current will now flow, limiting the voltage imposed on downstream equipment.

Typically, the voltage now across the device, the Arc Voltage, can be a few 10's of volts depending on the rating. When the energy within the fault condition falls to a level that cannot maintain the Arc condition, the LVL will recover to its original 'no fault' condition. That is a high impedance, non-conducting state.

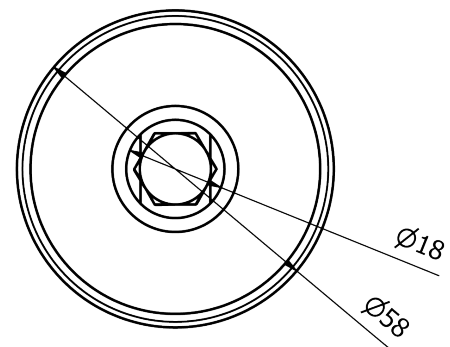

Revision: vPDS, 20/09/17  
Information subject to change without notice.

All of the above information, including drawings, illustrations and graphic designs, reflects our present understanding and is to the best of our knowledge and belief correct and reliable. Users, however, should independently evaluate the suitability of each product for the desired application.

