

ZOMM Series

(Zinc Oxide Military Modules)

ZOMM 123/5/4/4

PD Devices Ltd manufacture a wide range of products to protect against the effects of high altitude detonation of Nuclear devices. The result of such an event is the generation of Electromagnetic Pulses which will induce a high voltage transient in exposed conductors.

The EMP can affect several thousands of square kilometres, with a magnitude of tens of kilovolts.

This could result in serious damage to insulation, cause breakdown of semiconductors and the consequent malfunction of critical equipment.

Most notable would be the failure of Energy Power Supply and Communications Systems. We offer products to satisfy protection for most applications



Specification	
No. of channels	4
50 Shot (4/20µs) Repetitive Duty	5000A
Response Time	<10ns
Continuous Current per Channel	600A
Max. (8/20µs) Current per Channel	50000A
Leakage Current per Channel at Rated Voltage, DC	<200µA
Through Inductance	<10µH
Volts Drop	Negligible
Terminations	24mm Copper
Bushes	PTFE
Earth Connection	To Base Plate
Recommended Torque per M18 Terminal	40Nm (Ensure terminal does not rotate)

Explanation of Order Code

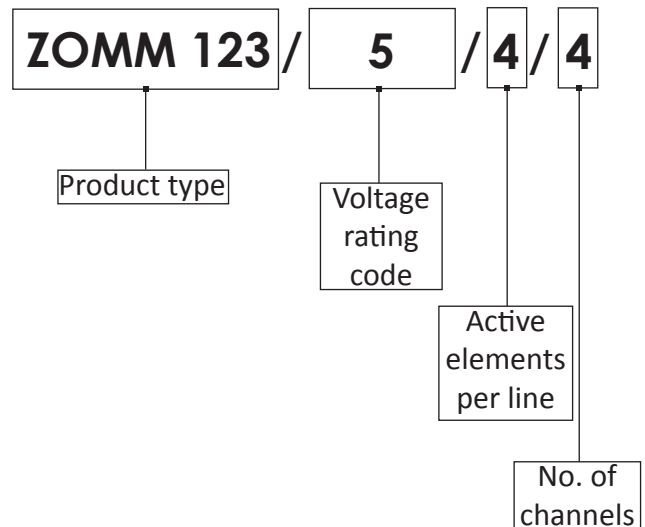

PD Devices reserves the right to amend specifications in line with product development.

(XXX)		1	2	3	4	5	6	7	8	9	10	11
Continuous Operating Voltage	AC (rms)	120	135	150	180	220	250	280	320	380	415	440
Energy per channel (Joules)	(10/1000µs)	400	480	500	520	640	720	840	920	1040	1160	1280
Max. Peak Clamping Volts @	100A (8/20µs)	330	370	410	500	620	680	790	870	1050	1140	1200

Revision: vPD1, 24/05/18
Information subject to change without notice.

All of the above information, including drawings, illustrations and graphic designs, reflects our present understanding and is to the best of our knowledge and belief correct and reliable. Users, however, should independently evaluate the suitability of each product for the desired application.



ZOMM Series

(Zinc Oxide Military Modules)

ZOMM 123/5/4/4



ZOMM 123/5/4/4 Diagram in mm

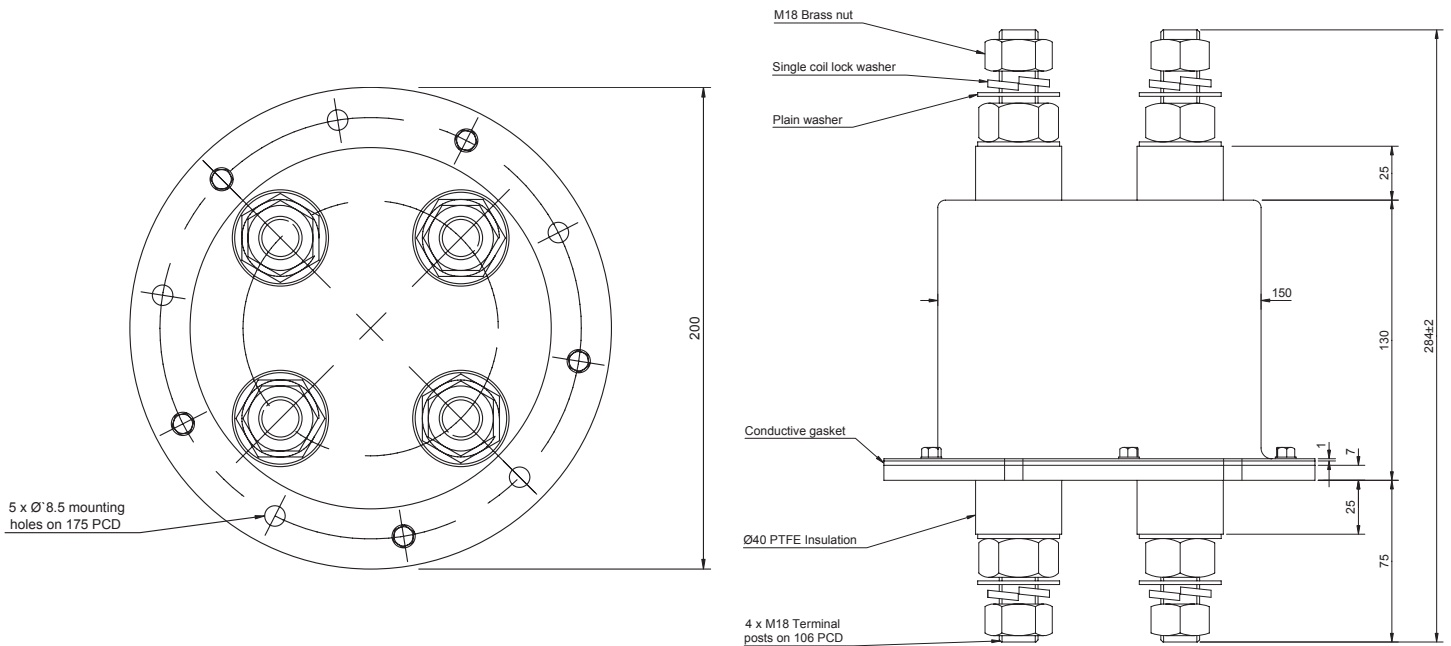

This ZOMM Application is recommended for Zone 0, 1 & 2

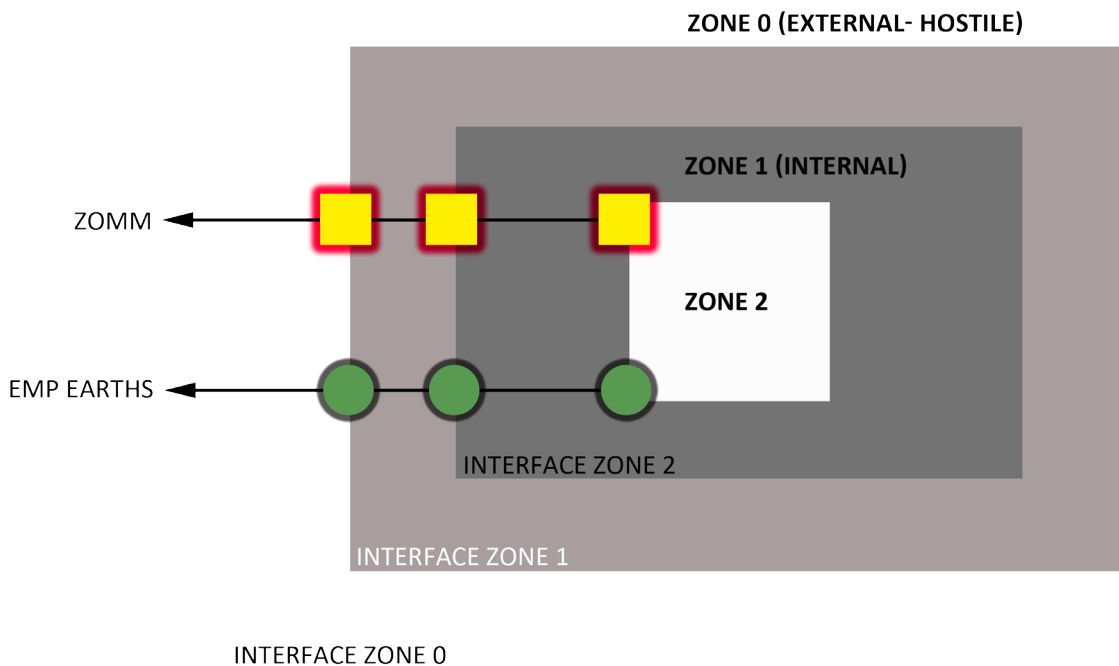

Revision: vPD1, 24/05/18
Information subject to change without notice.

All of the above information, including drawings, illustrations and graphic designs, reflects our present understanding and is to the best of our knowledge and belief correct and reliable. Users, however, should independently evaluate the suitability of each product for the desired application.

